

# SA-REFERENCE

*Power Amplifier  
Instruction Manual*



**PLINIUS**

*The heart of music*  
[www.pliniusaudio.com](http://www.pliniusaudio.com)



# CONTENTS

**PLINIUS**  
THE HEART OF MUSIC

Introduction	2
Design Philosophy	3
Unpacking	4
Placement & Ventilation	4
Precautions	5
Amplifier Features – Front Panel	6
Amplifier Features – Rear Panel	8
Installation and Operation	11
SA-Reference Features	16
Loudspeaker Selection	18
Specifications	19
Index	20

All operational, technical and descriptive material in this publication is subject to change at any time without notice. For further product information or queries, please contact your PLINIUS dealer.

PLINIUS products are designed and manufactured by Plinius Audio Limited, New Zealand.

[www.pliniusaudio.com](http://www.pliniusaudio.com)

# INTRODUCTION

CONGRATULATIONS on your decision to become the proud owner of this PLINIUS SA-Reference Power Amplifier.

This manual has been prepared to help you understand the operation of your amplifier, and to provide information about its design and the variety of ways it may be used.

We have designed and manufactured this amplifier to reproduce faithfully and accurately, your favourite music. With a little care and a full understanding of the operating recommendations in this manual, your PLINIUS SA-Reference Power Amplifier will provide years of high-quality, trouble-free performance.

SERIAL NUMBER \_\_\_\_\_

FINAL TEST CERTIFIED BY \_\_\_\_\_

**IMPORTANT:** PLEASE TAKE THE TIME TO READ THIS MANUAL THOROUGHLY BEFORE USING YOUR AMPLIFIER.

# DESIGN PHILOSOPHY

From a distance you can see that the design of the Plinius products is more than an applied styling exercise to the front panel. We have started from the ground up to produce a casing for our electronics that is unrivalled in its physical strength and visual simplicity.

Wherever possible we have reduced the number of parts needed and then invested massively in refining and producing the remaining parts to the highest quality achievable with state of the art computer controlled machines allied with expert craftsman. Examples of this approach include the hydraulically formed corners on the amplifiers giving much greater strength and the one piece housing for the remote control that looks, feels and genuinely is robust.

As with music that you are not familiar with, truly innovative new designs can take time to understand and enjoy. How often have you heard music that you were first unsure of, that over repeated listening, has become a firm favourite?

Our designs are fundamentally different to many other companies, and we hope that you will take the time to explore their unique character and qualities because we have not made them different simply to be different. We genuinely believe that their visual and tactile qualities do improve the experience of listening to music and that is our design goal!

The image shows a handwritten signature in black ink. The signature reads "ROSS.S" in a bold, cursive style. Below the signature is a thick, horizontal brushstroke underline.

Ross Stevens  
DESIGN DIRECTOR.

# UNPACKING

The PLINIUS SA-Reference is a very heavy amplifier and so requires to be shipped in a custom made crate. To open the crate you must locate and remove the 12 pozi drive screws around the base of the crate. Once all of the screws have been removed, the crate will lift off the base and expose the inner carton containing the amplifier.

Please take care when opening the carton as the unit sits just below the surface of the carton. Open the carton from the top and remove the accessories and polystyrene packing from each end. You may now proceed to lift the unit from the carton. You will require help with this as the unit is very heavy.



# PLACEMENT & VENTILATION

Your PLINIUS SA-Reference may operate at a moderately high temperature, especially during extended listening sessions. The ideal location is upon a rigid stand, or floor mounted away from direct contact with any temperature sensitive materials, furniture or deep pile carpets. Ventilation through and around the amplifier should also be kept unimpeded. Please ensure that the heat vents (slots in the lid and base) and the heatsink fins on either side are not covered or restricted in any way.

The PLINIUS SA-Reference design incorporates a very high level of mechanical decoupling of the input and output. It can however still be influenced by acoustical feedback in the operating environment. The use of acoustic cones or a suitably spiked amplifier stand or table may further enhance the performance of this amplifier. Consult your Plinius dealer for further advice if required.

# PRECAUTIONS



PLEASE TAKE SPECIAL NOTE OF THE FOLLOWING PRECAUTIONS BEFORE OPERATING YOUR NEW AMPLIFIER.

The PLINIUS SA-Reference Power Amplifier can be operated in mono mode delivering up to 1000 watts into 8 ohms. This amplifier is also capable of a very large peak current delivery.

The PLINIUS SA-Reference Power Amplifier operates in Class A. It is capable of generating temperatures that could have an adverse effect on other equipment, furniture etc. **DO NOT** leave flammable material on the amplifier whilst running, as this could pose a serious fire risk.

The PLINIUS SA-Reference Power Amplifier is of direct-coupled design, and offers no protection from preamplifiers that have a high DC component at their outputs.

This amplifier operates at hazardous voltage levels. Any work requiring removal of the lid or base of this amplifier must be referred to a suitably qualified and experienced service technician.

**DO NOT** attempt to connect any input of this amplifier to its own outputs.

**DO NOT** earth any output terminal or connect any of these terminals together without following the instructions in this manual or seeking qualified assistance.

**DO NOT** place this amplifier in any position where liquids or any foreign material may accidentally enter it.

**DO NOT** connect any voltage source, short circuit, earth/ground or appliance (other than suitable high fidelity loudspeakers) to the amplifier output terminals.

Some preamplifiers, processors, CD players' etc. produce large switching pulses when switched on causing a loud click through the loudspeakers. For this reason, turn on all other equipment in your system before turning on your PLINIUS SA-Reference, or ensure that the amplifier is in MUTE. You will not experience this phenomenon with PLINIUS Preamplifiers.

# AMPLIFIER FEATURES – FRONT PANEL

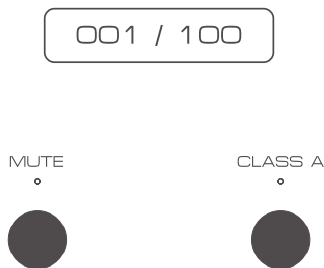

ABOVE: SA-Reference front panel layout

## POWER LED

An LED in the centre of the front panel indicates that the power is on. When first switched on, the display LED will vary in brightness until the initialisation sequence is completed, after which the LED remains lit.

## MUTE SWITCH

It is not recommended practice to interfere with the input cables while the amplifier is switched on and connected to the loudspeakers, so a Mute button is fitted to interrupt the input signal. This allows you to connect and disconnect the input cables without the necessity of turning the amplifier off.

When the amplifier powers up from start, it will automatically go into Mute and disconnect the speaker outputs. In this mode the Mute LED is ON. Press the Mute switch to take the unit out of Mute and begin listening.

## CLASS A SWITCH

This switch on the right of the panel alters the operating bias of the amplifier. Press once to activate Class A, and again for Class AB. In Class A the LED is ON. Either mode may be used for listening, with Class A preferred.

CLASS AB: This position reduces the bias on the output stage to operate the amplifier in Class AB. This is a bias configuration used by the majority of high fidelity amplifiers. In Class AB your PLINIUS SA-Reference produces very high quality sound, suitable for all occasions where critical listening is not a priority. A dual benefit exists in that



this facility provides the user with a much cooler operating temperature, and a much reduced demand on the mains electricity supply, particularly at idle while the amplifier is not reproducing music. This feature allows you to leave the PLINIUS SA-Reference switched ON at all times, rendering the amplifier ready for use and requiring only a few minutes of warm-up in Class A before the very best of the amplifier's sonic qualities may be experienced.

CLASS A: This position provides Class A bias to the output stage therefore ensuring the optimum performance of the amplifier during all listening events.

Class A amplifiers run hotter than Class AB amplifiers, hence our specially designed and distinctive heat sinks. Operating the amplifier in Class A necessitates two precautions that should be observed.

1. On switching to Class A, the temperature of the amplifier will quickly increase and the amplifier will become quite hot. Ensure that you have left adequate space around the amplifier for ventilation.
2. The power required from the mains supply in Class A is approximately 1,000 watts, similar to a small electric heater. The amplifier should not be connected to a wall outlet that is shared with other heavy current appliances such as heaters or electric motors. If in doubt, check with your Plinius dealer for advice.

### **WHY CLASS A IS BETTER**

Class A has always been regarded as the perfect operating mode for audio amplifiers. Many leading amplifier designers and manufacturers world wide recognise that a well designed Class A circuit has inherently lower distortion than any other design.

Class A circuit topology is one in which the total current the amplifier is capable of delivering, is kept flowing in the circuit regardless of demand. In a conventional or Class AB amplifier circuit this current flow varies when demand varies. Furthermore, as current varies, the voltage on the power supply rails (as seen by the output stage) varies too.

In a Class A circuit, current draw should be constant therefore there is an absence of the power supply modulation common in Class AB design amplifiers. Pinpoint images, tonal clarification, intertransient silence, more readily defined dynamic shadings, inner detail and authority are all inherent advantages of good Class A design.

# AMPLIFIER FEATURES – REAR PANEL

This panel incorporates all the terminals for connecting the input signals from your preamplifier, and output to the loudspeakers, and mains supply. A reasonable understanding of this amplifier's operation and a logical approach should ensure that you are able to make all connections with ease.

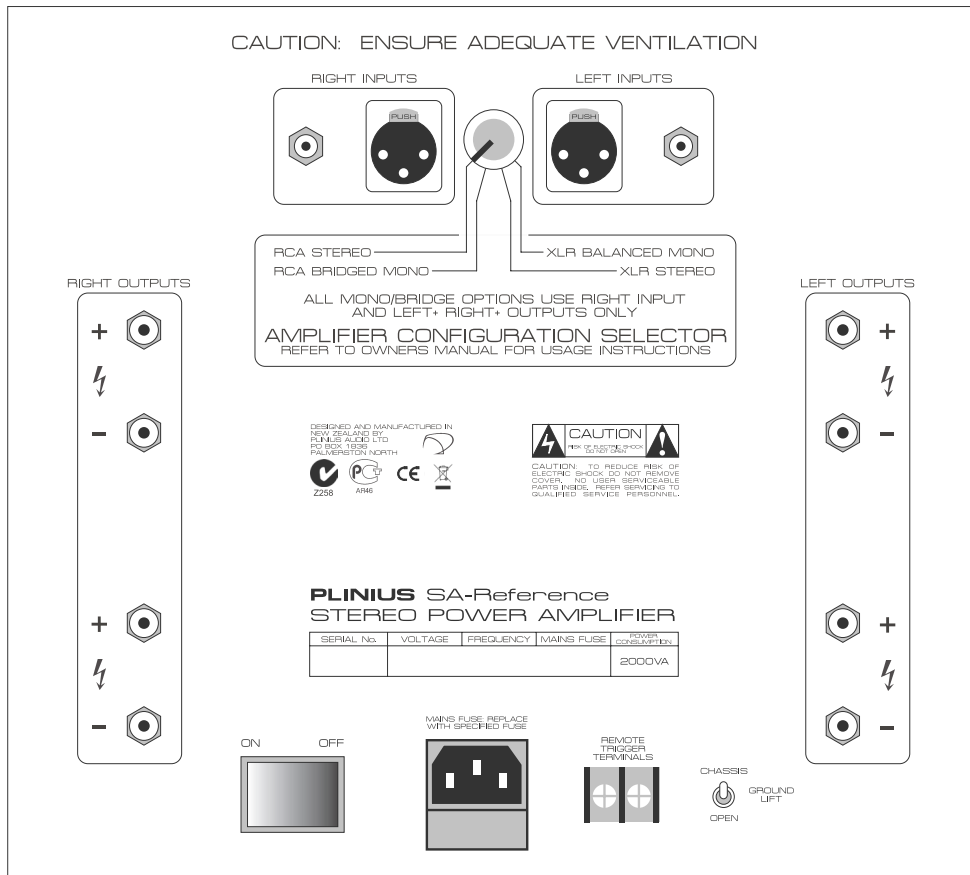

ABOVE: SA-Reference rear panel layout

## INPUT TERMINALS

Input terminals for your PLINIUS SA-Reference Power Amplifier are easily accessible and fitted near the top centre area of the rear panel.

**RCA INPUTS:** These standard RCA terminals are for use with unbalanced signals from most signal sources such as audio preamplifiers.

XLR BALANCED INPUTS: XLR connectors fitted to this amplifier are for use with balanced line signals from audio preamplifiers. Balanced signals are carried via a three way cable that connects all three pins at each end of the interconnect cable.

The XLR input pin configuration used in all Plinius product is as follows:

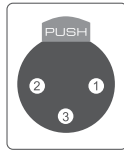

PIN 1 to GND  
PIN 2 to +Signal  
PIN 3 to -Signal

**NOTE:** Because of the way balanced XLR inputs are configured it is not possible to connect both XLR and RCA at the same time.

### AMPLIFIER CONFIGURATION SELECTOR (ACS)

The Amplifier Configuration Selector (ACS) is a unique switching method that exploits all of the operational features of your PLINIUS SA-Reference Power Amplifier. By using this switch it is possible to operate your amplifier with either balanced or unbalanced signals and achieve a stereo or mono output.

Stereo or Mono use of this amplifier will depend on the type of ancillary equipment employed with your system. If you wish to use this amplifier as a single channel (mono) Power Amplifier in a stereo high fidelity system, then another SA-Reference will be required for the other channel. This will provide an extremely high performance option.

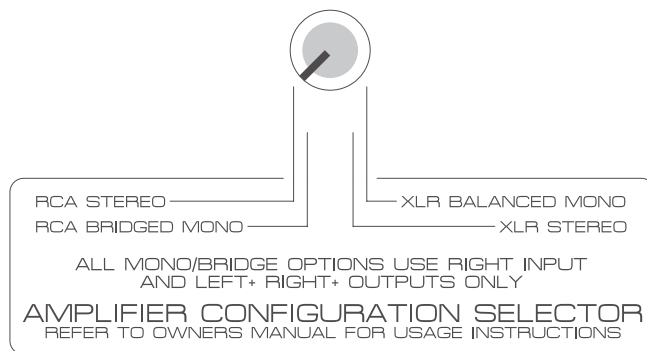

The ACS switch options are:

**RCA STEREO:** This option provides a stereo output via both left and right output channels from a stereo signal connected to both left and right input RCA inputs.

**RCA BRIDGED MONO:** This option configures your amplifier to drive one loudspeaker from one unbalanced signal fed to the RIGHT RCA input.

XLR STEREO: This option provides a stereo output signal from a balanced stereo input signal connected to both the left and right XLR inputs.

XLR BALANCED MONO: In this mode both channels of your PLINIUS SA-Reference combine to operate as a true balanced mono amplifier, from input to output. This configuration provides the highest quality mono performance from a balanced line input connected to the RIGHT BALANCED XLR INPUT.

### **BALANCED/UNBALANCED SIGNALS**

Balanced or unbalanced input options will depend on the type of signal available from your preamplifier or other equipment. The PLINIUS SA-Reference provides both options to allow you to choose the most suitable preamplifier for your purposes. PLINIUS Preamplifiers offer both balanced and unbalanced output options.

BALANCED LINE is normally used to transmit signals in a professional environment. Because balanced line effectively reduces or eliminates noise pick-up by the system cabling, it has become increasingly more important in high-quality domestic high fidelity systems.

UNBALANCED leads such as single ended, RCA or coaxial are common and are used in the majority of audio signal systems. The terminal plug and socket are most commonly called RCA and can be found on your PLINIUS SA-Reference for use as the standard input terminals for both left and right inputs.

### **OUTPUT TERMINALS**

Output connections for the loudspeakers are provided on the left and right hand side of the rear panel. Two parallel pairs of binding posts for each channel are fitted – these provide ease of use with bi-wiring and multiple cables requiring a large contact area.

### **MAINS SWITCH**

This heavy-duty rocker switch on the rear panel turns the Mains/Line Power to the amplifier ON or OFF. The amplifier draws a moderately high current when switched on. Despite the "Soft Start Circuit" within the amplifier reducing current demand on the mains as the amplifier is switched on, it is not good practice to rapidly turn the Mains switch on and off repeatedly.

### REMOTE TRIGGER TERMINALS

In order to integrate more effectively into a home theatre system, the PLINIUS SA-Reference has remote trigger terminals fitted to the rear panel. By connecting a processor with a remote trigger signal to these terminals, the SA-Reference can be put in and out of Class AB/mute by the processor to which it is connected. When in Class AB/mute the amplifier draws less current and will operate at minimum temperature. The output relays are also open, disconnecting the loudspeakers. This may be of advantage in a multi-amplifier and/or remote installations. Polarity of the connections to the remote trigger is not important.

### GROUND LIFT SWITCH

This switch is located adjacent to the Mains Input Socket, and allows the signal ground to be disconnected from the chassis. In some installations a hum loop may exist due to duplicate ground paths from different equipment. Use this switch to remove the connection from 0V to ground thus allowing some flexibility in your particular set-up. Note that in both XLR modes the ground lifting switch should always be set to 'chassis'.

### MAINS POWER CORD IEC CONNECTOR

This connector is where the mains supply cable from your wall connects to the amplifier. You will notice that a fuse holder is mounted within this connection, and it holds a mains fuse to provide surge and overload protection for your amplifier.

## INSTALLATION AND OPERATION



### WARNING: RISK OF ELECTRIC SHOCK

This amplifier operates at hazardous voltage levels. We recommend that any work requiring removal of the lid be referred to a suitably qualified and experienced service technician. **DO NOT** place this amplifier in any position where liquids or any foreign material may accidentally enter it.



### CAUTION!

PLEASE READ AND UNDERSTAND THE PRECAUTIONS IN THE INSTRUCTION MANUAL FOR THE POSITION AND OPERATION OF YOUR PLINIUS AMPLIFIER.



## CONNECTIONS

Connections to your PLINIUS SA-Reference should be made in the same order as they are listed in this section. **DO NOT** attempt to connect your PLINIUS SA-Reference until you have read and fully understood these instructions.

Although these instructions refer to the connection of a preamplifier, the SA-Reference can also be safely installed into multimedia systems by following the same installation guidelines. Should you require any further assistance, please contact your Plinius dealer.

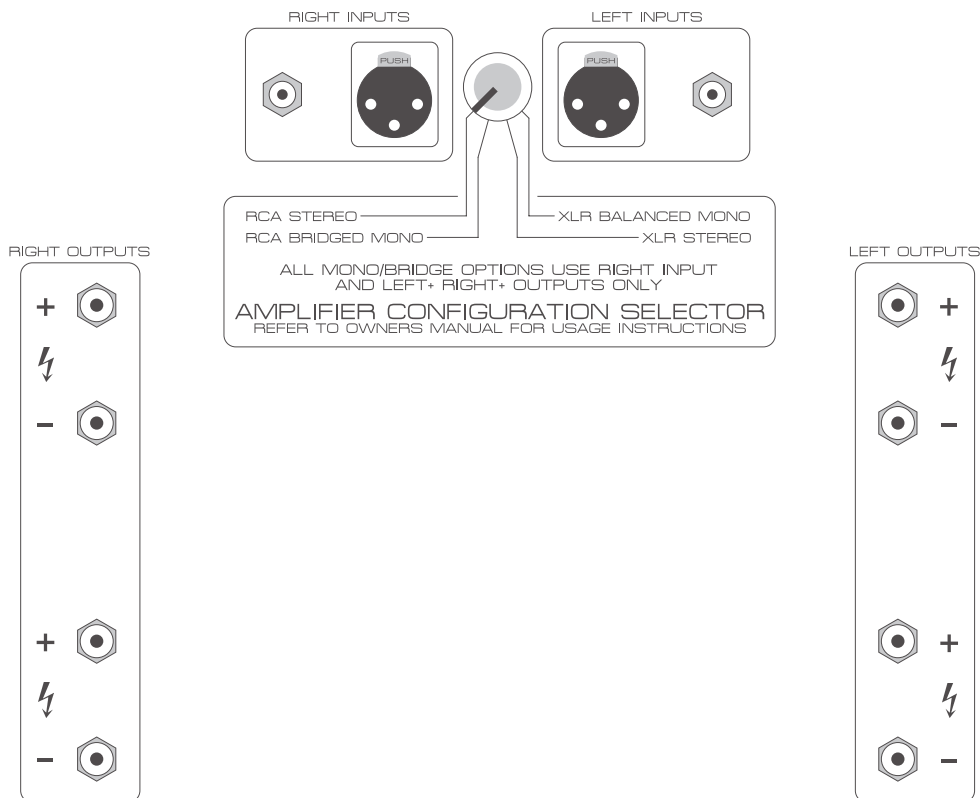

ABOVE: Rear panel layout showing input and output terminals



## PREAMPLIFIER INPUTS

Connect your Preamplifier to the input of the PLINIUS SA-Reference using suitable single-ended RCA or Balanced XLR interconnect cables only.

If using single-ended RCA inputs, connect your Preamplifier to the RCA inputs on the back of the PLINIUS SA-Reference. Make sure you connect the red coded cable to the red RIGHT RCA input, and the black (or white) cable to the black LEFT RCA input. Also make sure the RCA connectors are a snug fit and are inserted all the way in.

For XLR input connection, make sure you connect the RIGHT XLR input and LEFT XLR inputs to the right and left outputs from your Preamplifier respectively.

Use the Amplifier Configuration Selector switch to select RCA STEREO if you are using unbalanced RCA inputs or to select XLR STEREO if you are using balanced XLR inputs.

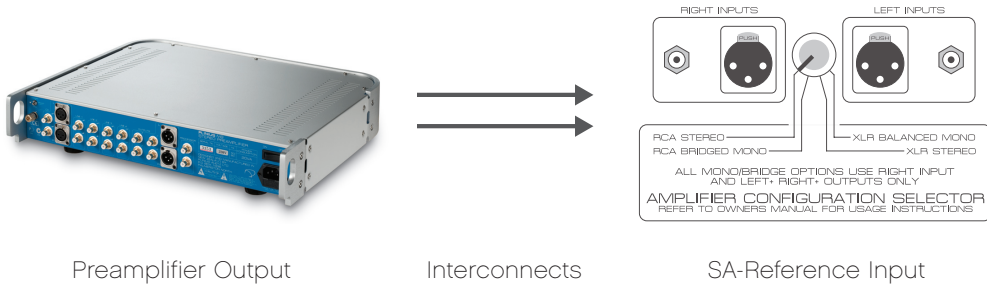

**NOTE:** DO NOT connect XLR and RCA at the same time, use only one or the other. Detailed instructions for using the SA-Reference in RCA BRIDGED MONO, and XLR BALANCED MONO modes are later in this section.



### LOUDSPEAKER OUTPUTS

The connection of your loudspeakers to the output posts of the PLINIUS SA-Reference must be made by an 'instructed person' or by ready made loudspeaker cables only.

Connect your left loudspeaker (ie. the one on your left when seated in your normal listening position) to the left output terminals, ensuring that the red positive (+) terminal on the amplifier is connected to the red positive (+) terminal on your loudspeaker. Do the same with the black or negative (-) terminals. Repeat this process for the right outputs.

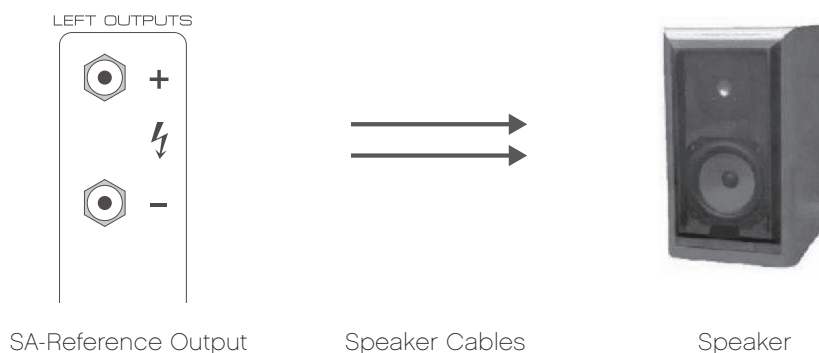

## **TERMINATION QUALITY**

Quality of the connections must be examined to ensure that high performance trouble free operation is enjoyed. Check that the connections are tight but do not over tighten. If bare wires are used make sure that no loose strands of wire short cross the other terminals or the amplifier chassis. When using plugs such as bananas, be sure to use good quality plugs with a firm fit.

## **BI-WIRING**

Bi-wiring uses two pairs of loudspeaker cables for each channel loudspeaker. You will notice that the rear panel of your PLINIUS SA-Reference has two pairs of output terminals for this purpose. When using bi-wires in a STEREO installation, connect each wire pair to a corresponding pair of binding posts (one cable to the top pair, one cable to the bottom) paying special attention to positive (+) red and negative (-) black polarity. With a MONO setup remember that your speaker wires must use the red positive (+) output posts ONLY. Connect one speaker cable to the top positive (+) red binding posts, and the other speaker cable to the lower positive (+) red binding posts.

## **PHASING (OR POLARITY)**

It is important to achieve good stereo imaging in your listening room. By observing the wiring instructions above, each Power Amplifier/loudspeaker combination should be in phase. If you experience poor stereo image and/or a lack of bass, check that the loudspeaker wiring has been connected correctly. We recommend that you use one of the easily obtainable 'test discs' to help you ensure both phasing and channel orientation are correct. If in doubt, consult your Plinius dealer for advice.

To achieve a sound performance that is correctly aligned to your room, make sure all of the leads carrying signals for the right channel loudspeaker are connected to the right input to the amplifier from your preamplifier or cd player etc. Signals for the left channel should be wired in a similar fashion.



## **BRIDGED/MONO CONNECTIONS**

There are essentially four different ways that you can connect your system components to the PLINIUS SA-Reference Power Amplifier:

1. RCA STEREO
2. RCA BRIDGED MONO
3. XLR STEREO
4. XLR BALANCED MONO



### **RCA BRIDGED MONO**

This option configures your amplifier to drive one loudspeaker from one unbalanced signal fed to the red RIGHT RCA input. In bridged mono mode the only input made to your preamplifier is to the red RIGHT channel RCA input. The black LEFT channel RCA input is not connected.

Next your loudspeakers are connected to both positive (+) channel output terminals. So the positive red connection on your loudspeaker is connected to the red RIGHT amplifier output, and the negative black connection on the loudspeaker should be connected to the red LEFT amplifier output.

**DO NOT** CONNECT ANYTHING TO THE NEGATIVE (-) TERMINALS. MAKING A CONNECTION TO THE NEGATIVE (-) TERMINALS OF THE AMPLIFIER IN THIS MODE CAN CAUSE SERIOUS DAMAGE!

You can still connect two loudspeakers using the lower positive (+) amplifier output terminals. This is explained in the bi-wiring section previous. Now turn the ACS switch fully clockwise then one position counter-clockwise so that it is in the RCA Bridged Mono position.

### **XLR BALANCED MONO**

As with RCA Bridged Mono, this option configures your amplifier to drive one loudspeaker, but from one balanced line input connected to the RIGHT XLR Input. In balanced mono mode the only input made to your preamplifier is to the RIGHT channel XLR input. The LEFT channel XLR input is not connected.

Next your loudspeakers are connected to both positive (+) channel output terminals. So the positive red connection on your loudspeaker is connected to the red RIGHT amplifier output, and the negative black connection on the loudspeaker should be connected to the red LEFT amplifier output.

**DO NOT** CONNECT ANYTHING TO THE NEGATIVE (-) TERMINALS. MAKING A CONNECTION TO THE NEGATIVE (-) TERMINALS OF THE AMPLIFIER IN THIS MODE CAN CAUSE SERIOUS DAMAGE!

You can still connect two loudspeakers using the lower positive (+) amplifier output terminals. This is explained in the bi-wiring section previous.

Now turn the ACS switch fully counter-clockwise so that it is in the XLR Balanced Mono position.



## CONNECTING THE MAINS SUPPLY

Firstly, check that the mains supply voltage printed on the rear of this amplifier is similar to the mains supply voltage in your area. If in doubt, please consult your Plinius dealer. Mains supply power connection is via the plug-in lead supplied with your PLINIUS SA-Reference.

Check the wall outlet is switched OFF, then connect the local mains plug end of the lead to the wall outlet. Check the SA-Reference is switched OFF, and connect the IEC end of the cable to the IEC socket at the back of the SA-Reference. With the cord fully connected, switch the wall outlet ON.

Now that your PLINIUS SA-Reference is configured correctly, switch the power switch on the rear panel to ON. The display LED will cycle in brightness for approximately ten seconds as the internal circuitry stabilises. Use the MUTE switch on the front panel to take the unit out of MUTE and you can now enjoy your new PLINIUS SA-Reference Power Amplifier.

**NOTE:** This unit must be connected to a mains socket outlet with a protective earthing connection. The wall outlet socket or SA-Reference mains switch must be accessible at all times in case of emergency.

## WARM-UP PERIOD

You will find that the PLINIUS SA-Reference will become noticeably 'purer' in sound after being on for a period of time. We usually recommend waiting at least 24 hours before expecting the best quality of sound reproduction from your amplifier. We suggest leaving the unit turned on so that it will always be at it's sonic best.

# SA-REFERENCE FEATURES

## ERROR DETECTION

The PLINIUS SA-Reference Power Amplifier has in-built error detection. This will function under the following conditions:

- 1) When the amplifier is overdriven/clipped
- 2) If any internal fuse is damaged

Should either of these circumstances arise the amplifier will disconnect both

channels and mute the input. This condition will remain until the input signal level is reduced or the damaged fuse replaced. When error detection is triggered the power LED will turn off and the mute LED will pulse. The internal error LED (located towards the front of the circuit board in the top cavity of the amplifier) will also light.

## FUSE PROTECTION

When any internal fuse is damaged one or more fuse warning LEDs will light. These LEDs are under the amplifier lid located to the front right of the main circuit board. Should any of the internal fuses need to be replaced, ensure that your amplifier is switched OFF and disconnected from the mains supply for at least 30 minutes. The base of the amplifier will then need to be removed and the fuses located. The rail fuses are near the middle of the circuit board. Replace them with the same type only.

**IMPORTANT:** DO NOT FIT A FUSE WITH A HIGHER RATING.

**NOTE:** Fuse failure may indicate a severe problem. Check all speakers and speaker cables for damage etc. Should the amplifier continue to exhibit rail fuse failure contact your Plinius dealer.

## ECOLOGIC CONTROL

The PLINIUS SA-Reference is also fitted with a microprocessor which monitors and performs the Bias and Mute functions. It is programmed to switch the amplifier back into Class AB if no signal has been present at the input for a predetermined time. This time can be adjusted to Off, 15, 30 or 60 minutes. During the last minute without signal the bias LED will pulse to indicate the unit is about to return to Class AB. The purpose of this function is to prevent the amplifier being left in Class A while unattended for a long period of time.

Before adjusting this time constant, ensure that your amplifier is switched OFF and disconnected from the mains supply. Remove the amplifier lid and locate the small jumper JP1 on the main circuit board at the front left. Adjustments are then made by shifting the jumper to the appropriately labelled pins. The factory setting is 30 minutes.

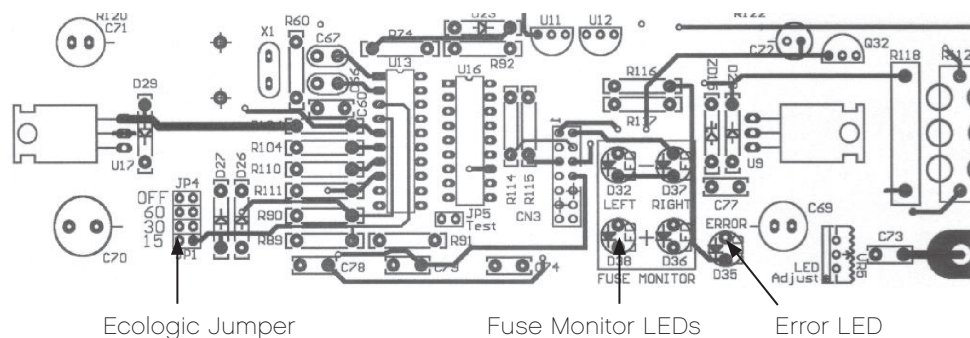

## **MAINS/LINE FUSE**

A Mains/Line fuse is fitted within the IEC Mains/Line socket on the rear of the amplifier. A small drawer at the bottom of this socket may be removed (after the IEC plug is removed) by levering it out with a flat blade screwdriver. The fuse fitted should be rated as specified on the rear panel.

In the unusual event that this fuse should blow, you must first establish the cause of this failure (such as power surges, damaged mains cable etc.) before replacing the fuse with one of the same rating and type.

**IMPORTANT:** DO NOT FIT A FUSE WITH A HIGHER RATING.

**NOTE:** Fuse failure may indicate a severe problem. Should the amplifier continue to exhibit mains fuse failure contact your Plinius dealer.

# LOUDSPEAKER SELECTION

Your PLINIUS SA-Reference Power Amplifier is designed for use with high fidelity loudspeakers. It should not be used to operate any other type of appliance or equipment.

Choice of loudspeakers is one of personal taste, providing the chosen loudspeakers are suitable for use with your amplifier. Be certain that your loudspeakers can handle most of the rated output power of this amplifier. You may find loudspeaker specifications confusing or misleading so you should discuss this with your audio dealer prior to purchase. As a general rule, the use of high power (200 watt RMS or greater) loudspeakers is recommended and desirable. However, our experience indicates that medium to low power loudspeakers (100 to 200 watt RMS) are quite often suitable for use with this amplifier provided the volume is maintained at a level where no distortion is audible.

Impedance of the loudspeaker load is important to ensure the rated performance of this amplifier. Any combination of loudspeakers may be used but the total average impedance load for each channel should be within a range of 4 to 8 ohms. Again, if you have doubts about the impedance of your loudspeaker configuration, we recommend you speak to your Plinius dealer.

# SPECIFICATIONS

300 Watts RMS per channel into 8 ohms.

450 Watts RMS per channel into 4 ohms.

Both channels driven from 20Hz to 20kHz at 0.05% total harmonic distortion.

## MONO OUTPUT

1000 Watts RMS 20Hz to 20kHz into 8 ohms

## DYNAMIC HEADROOM

1dB or greater at 8 ohms with music

## FREQUENCY RESPONSE

20Hz to 20kHz +/-0.2dB. 0dB at 0Hz and -3dB at 70kHz

## DISTORTION

Typically <0.05% THD at rated power

0.1% THD and IM worst case prior to clipping

## VOLTAGE SWING

130Vpp per channel

## CURRENT OUTPUT

100A short duration peak per channel. Fuse protected

## RISE TIME

Typically 4us

## SLEW RATE

>50V/us

## HUM & NOISE

100dB below rated output 20Hz to 20kHz A-weighted

## GAIN

32dB Unbalanced, 38dB Balanced

## INPUT IMPEDANCE

47k

**HEIGHT** 275mm (10 3/4")

**WIDTH** 510mm (20")

**DEPTH** 535mm (21")

**WEIGHT** 57kg (125lbs)

# INDEX

ACS (Amplifier Configuration Selector)	9, 13, 15
Balanced Signal	10
Bias Class A	7
Bias Class AB	6
Bias Switch	6
Bi-wiring	10, 14
Ecologic Control	17
Error Detection	16
Front Panel Layout	6
Fuse Protection	17, 18
Ground Lift Switch	11
IEC Power Connector	11, 16
Input Terminals	8, 10, 12
Loudspeaker Impedance	18
Loudspeaker Power	18
Mains/Line Fuse	18
Mains Supply Connection	16
Mains Switch	10
Mono Operation	9, 14, 15
Mute Switch	6
Operating Temperature	6, 7
Output Terminals	10, 13
Phasing	14
Placement	4, 11
Rail Fuses	17
RCA Bridged Mono Input	9, 15
RCA Stereo Input	9, 13
Rear Panel Layout	8
Remote Trigger	11
Safety Precautions	5
Serial Number	2
Stereo Operation	9, 12, 13, 14
Terminations	14
Unbalanced Signal	10
Ventilation	4, 11
XLR Balanced Mono Input	10, 15
XLR Stereo Input	10, 13